

# ASSOCIATION EURATOM – MEDC ROMANIA

## Overview

of participation of the Romanian Association  
to the EURATOM research in thermonuclear fusion in 2009

Florin Spineanu, Head of Research Unit  
“Association Days Meeting” Iassy 2 July 2010

# The year 2009 and first part of 2010

Research Groups from 7 Institutions:

4 National Institutes (Plasma, Tritium, Nuclear, Materials)  
3 Universities (Iassy, Craiova, Cluj-Napoca)

28 Task Agreements (contracts with EFDA and EFDA-JET)

Topical groups (transport, MHD, diagnostics, etc.)  
Plasma Wall Interaction  
Integrated Tokamak Modeling  
Materials

Enhancement Project at JET (Tungsten, Beryllium, diagnostics)

More substance for F4E - RO

# Where is the Romanian EURATOM Association ?

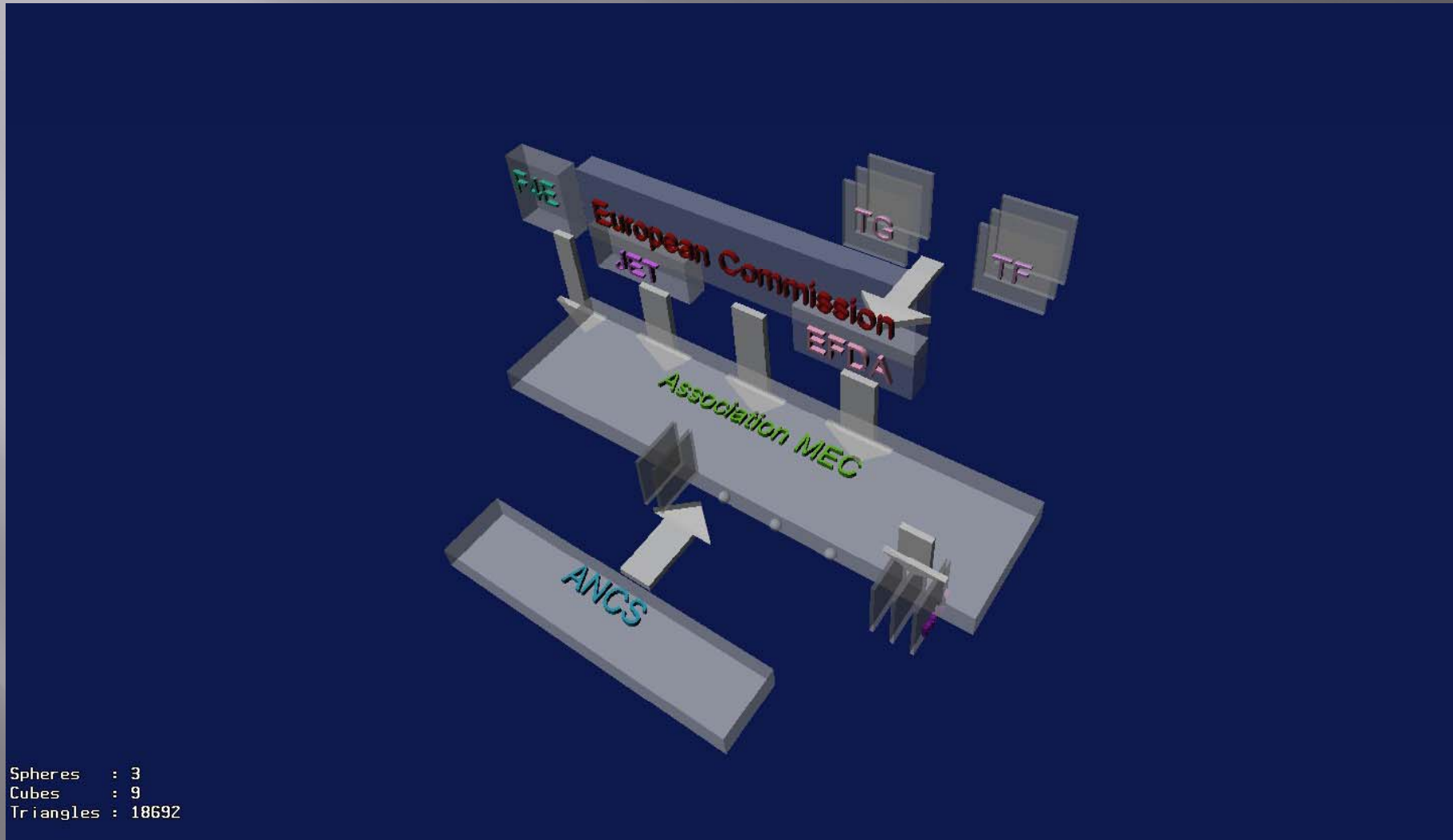

An interface between: Commission (+EFDA+JET), ANCS, Institutes

2009 – 2010  
Almost all activities are  
covered by Task Agreements

Active Projects  
(2010)

F. Spineanu, Overview Association Day 2010, Iassy

## Contracte 2010

## BASELINE SUPPORT

Nr. Crt.	Cod tema	Code Task Agreement	Support Baseline / Priority Support (ppy)	Responsabil	Specific Objective
1	BS_1	WP10-MHD-03-03-xx-02/MedC WP10-ITM-IMP12-ACT9-T1-01/MedC	Baseline	Atanasiu	Interpretation and control of helical perturbation in tokamaks
2	BS_2	WP10-TRA-01-04-xx-01/MedC	Baseline	Spineanu	Equilibrium flows and threshold conditions for accessing high confinement regimes and understanding
3	BS_3A	WP10-TRA-03-01-xx-01/MedC WP10-TRA-03-03-xx-01/MedC WP10-TRA-05-01-xx-01/MedC WP10-TRA-01-05-xx-01/MedC WP10-ITM-IMP5-ACT4-T1-01/MedC	Baseline Priority ITM (0.5)	Pometescu, Steinbrecher	Anomalous transport in plasmas. Role of collisions, turbulence and wave-plasma interaction in transport. Application to ITER. Model for Edge Plasma Turbulence
4	BS_3B	WP10-TRA-05-01-xx-01/MedC	Baseline	Negrea	Anomalous transport in plasmas. Stochastic processes and transport in turbulent plasmas
5	BS_4A	WP10-ITM-ISIP-ACT3-T1-01/MedC WP10-ITM-ISIP-ACT10-T1-01/MedC	Priority ITM (0.4) Priority ITM (0.8)	Stancalie	ITM-Portal
6	BS_4B	WP10-ITM-AMNS-ACT2-T1-01/MedC WP10-ITM-AMNS-ACT3-T1-01/MedC	Baseline Priority ITM (0.3)	Stancalie	ITM-AMNS
7	BS_13	WP10-MHD-03-03-xx-01/MedC	Baseline	Miron	Theoretical modeling of the resistive wall modes feedback control considering neoclassical toroidal viscosity and error field penetration
8	BS_6	WP10-PWI-04-04-01/MedC/BS	Baseline	Costin	Sheath properties and related phenomena of the plasma wall interaction in magnetised plasmas.
9	BS_14	WP10-TRA-01-02-xx-01/MedC WP10-TRA-05-01-xx-01/MedC	Baseline	Vlad Madalina	Understanding of the ExB drift nonlinear effects on transport and structure generation in turbulent tokamak plasmas
10	BS_18_A	WP10-PWI-06-01-01/MedC/BS WP10-PWI-06-01-01/MedC/PS	Baseline Priority	Lungu	Study of the thermal treatment influence in formation of the stable Be-C, Be-W and C-W alloys. TVA gun electron beam irradiation influence. (BS-PS)
11	BS_18_B	WP10-PWI-06-02-01/MedC/BS WP10-PWI-06-02-01/MedC/PS	Baseline Priority	Lungu	Study of the ternary system formation Be-C-W using thermionic vacuum arc method; Influence of hydrogen/deuterium inclusion into the
12	BS_19_A	WP10-PWI-02-04-01/MedC/BS	Baseline	Dinescu	Codeposited material removal with a plasma torch. Removal of codeposited materials from gaps with plasma torch.
13	BS_19_B	WP10-PWI-02-04-02/MedC/BS	Baseline	Dinescu	Laboratory models for the codeposited layers
14	BS_19_C	WP10-PWI-02-04003/MedC/BS	Baseline	Dinescu	Production of controlled laboratory codeposited layers for fuel removal studies
15	BS_20_A	WP10-PWI-01-02-01/MedC WP10-PWI-01-02-02/MedC/PS	Baseline Priority	Tiseanu	X-ray micro-tomography studies on graphite and CFC samples for porosity network characterization (BS-PS)
16	BS_20_B	WP10-PWI-05-02-01/MedC WP10-PWI-05-02-02/MedC/PS	Baseline Priority	Tiseanu	X-ray micro-beam absorption/fluorescence techniques for erosion and deposition of wall materials (BS-PS)
17	BS_M_1	WP10-MAT-REMEV-01-01/MedC/BS	Baseline	Diamandescu Bibicu Ion	Transmission and backscattering Mössbauer Spectroscopy studies of the short range order, structure and magnetic properties in $\alpha$ -Fe and binary Fe-Cr model alloys WP10-MAT-REMEV
18	BS_M_2	WP10-MAT-ODSFS-01-01/MedC/BS	Baseline	Sarbu Corneliu	Microstructure characterization of ODS ferritic steels (ODSFS) by TEM, X-EDS, EELS and APT, WP10-MAT-ODSFS-01
19	BS_M_3	WP10-MAT-WWALLOY-01-01/MedC/BS	Baseline	Galatanu Andrei	Functional gradient W-Eurofer steel materials by unconventional co-sintering routes WP10-MAT-WWALLOY-01
20	BS_M_4	WP10-MAT-REMEV-06-01/MedC/BS	Baseline	Valentin Teodorescu	In-situ TEM observation of dynamics of screw & edge dislocations and He bubbles in a Fe and binary Fe-Cr model alloys subjected to ion irradiation versus temperature
21	BS_SC	Task Superconductors	Baseline	Traian Petrisor	Electrical, magnetic and mechanical characterisation of Re-123 superconducting cables and tapes
22	BS_9			Teddy Craciunescu	Optic flow methods for image processing of the data from the video camera KL7 at JET

# Active Projects 2010 (2)

## JET NOTIFICATIONS

Nr. Crt.	Cod tema			Responsabil	Specific Objective
23	BS_8	JW6-TA-EP2-GRS-05	JET Notification	Olariu	Gamma Ray Spectrometry Upgrade (GRS)
24	BS_15	JW9-TA-EP2-TCS-01	JET Notification	Soare	KM6T Tandem Collimator
25	BS_7	JW6-TA-EP2-GRC-04	JET Notification	Curuia	Upgrade of the JET KN3 Gamma-Ray Cameras Diagnostics
26	BS_12	WP10-PWI-01-01-01/MeDC	Baseline	Ruset	Providing W coated CFC samples for fuel retention measurements
27	BS_17	JW9-FT-3.50 JW9-NFT-MEC-16	JET Notification	Stan-Sion	AMS high sensitivity Tritium depth-profile (JW10-FT-3.60) measurements in PFC samples

NOT a JET Notification

## TRAINING

Nr. Crt.	Cod tema			Responsabil	Specific Objective
28	AS_8	WP08-GOT-TRI-TOFFY	Priority GOT	ICSI	Task Agreement WP08-GOT-TRI-TOFFY

## EFDA Article 5.1 B contracts (running Technology contracts)

Nr. Crt.	Cod tema			Responsabil	Specific Objective
29	TT12_5.1b	JW6-TA-EP2-ILC-05	Priority 5.1b	Ruset	ITER-like Wall Project at JET: Optimisation and manufacturing of 10 µm W-coatings for the CFC tiles to be installed in JET.
30	TT19_5.1b	JW6-TA-EP2-ILB-03	Priority 5.1b	Lungu	JW6-TA-EP2-ILB-02 Production of Beryllium Coatings for Inconel Cladding and Beryllium tile Markers for the ITER-like Wall project.

## EFDA JET Order Art. 6.3

Nr. Crt.	Cod tema			Responsabil	Specific Objective
31	F8_O	JW7-OEP-MEC-11		IFIN / OLARIU	Gamma Ray Spectrometry Upgrade (GRS)
32	TT12_O	JW6-OEP-MEC-06B		NILPRP / RUSSET	ITER-like Wall Project at JET: Optimisation and manufacturing of 10 micron W
33	BS_15_O	JW9-OEP-MEC-15		ICSI / Soare	Tandem Collimators Order
34	BS_7_O	JW6-OEP-MEC-13A		ICSI / CURUIA	Gamma ray cameras neutron attenuators Order missions +
35	Z_CSU	Secondment Agreement 1699		INFLPR / Zoita	Secondment Agreement to CSU Culham
36	TT19_O	JW6-OEP-MEC-09C		NILPRP / LUNGU	JW6-TA-EP2-ILB-02 Production of Beryllium Coatings for Inconel Cladding and Beryllium tile Markers for the ITER-like Wall project.

NU EXISTA

# Task Agreements with Preferential Support - 2009

## Association EURATOM - MEdC Romania

### LIST of Task Agreements with Preferential Support 2009

no.	Task Agreement	Title	MEdC Responsible	EFDA Responsible Officer	EFDA Contact Person	Date of Report	Priority Support	Contribution from Commission
1	WP09-PWI-01-01/MEdC/PS	SEWG Fuel Retention	Ion Tiseanu (1)	Roman Zagorski	Thierry Loarer	22-Dec-09	13,400.00	2,680.00
2	WP09-PWI-04-04/MEdC/PS	Errosion Transport and Deposition	Ion Tiseanu (2)	Roman Zagorski	Sebastijan Brezinsek	22-Dec-09	13,400.00	2,680.00
3	WP09-PWI-02-95/MEdC/PS	SEWG Fuel removal	G.Dinescu	Roman Zagorski	Emmanuelle Tsitrone	15-Dec-09	20,030.00	4,006.00
4	WP09-PWI-07-02/MEdC/PS	SEWG Material Mix	C. Lungu (1)	Roman Zagorski	K. Krieger	31-Dec-09	18,200.00	3,640.00
5	WP09-PWI-07-02/MEdC/PS	SEWG Material Mix	C. Lungu (2)	Roman Zagorski	K. Krieger	31-Dec-09	18,200.00	3,640.00
6	WP08-09-TGS-01b /06	Topical Group H&CD, MHD, Transport	G. Steinbrecher	Boris Weyssow	Boris Weyssow	31-Dec-08	2,780.00	556.00
						31-Dec-09	2,220.00	444.00
7	WP09-TGS-01a/04/ MEdC / PS	Topical Group H&CD, MHD, Transport	C. Ruset	Giorgio Maddaluno	Danilo Pacella	20-03-10	5,000.00	1,000.00
8	WP09-ITM-ISIP-T1	ITM - ISIP	V. Pais	Denis Kalupin	Lars Eriksson	31-Jul-09	8,800.00	1,760.00
9	WP09-ITM-ISIP-T3	ITM - ISIP	V. Pais	Denis Kalupin	Lars Eriksson	31-Jul-09	13,200.00	2,640.00
10	WP09-ITM-ISIP-T10	ITM - ISIP	V. Pais	Denis Kalupin	Lars Eriksson	31-Dec-09	17,600.00	3,520.00
11	WP09-ITM-TFL2-AMNS-T3	ITM-EFL2	V. Stancalie	Denis Kalupin	Lars Eriksson	31-Jul-09	13,000.00	2,600.00
<b>TOTAL</b>							<b>145,830.00</b>	<b>29,166.00</b>

# PWI 2010

No	Cod EFDA	Responsabil	Tema	Manpower	Contributie Comisie 8.2a	Hardware	Contributie Comisie 8.2b	Baseline	Obs
1.	WP10-PWI-01-01-01/MEdC/BS	Ruset	Providing W coated CFC samples for fuel retention measurements					0.30 ppy	
2.	WP10-PWI-01-02-01/MEdC/BS	Tiseanu	X-ray micro-tomography studies CFC samples for porosity network characterization					0.65 ppy	
3.	WP10-PWI-01-02-02/MEdC/PS	Tiseanu	X-ray micro-tomography studies CFC samples for porosity network characterization	14,350	2,870		0		
4.	WP10-PWI-05-02-01/MEdC/BS	Tiseanu	X-ray microbeam absorption/fluorescence method as a non-invasive solution for investigation of the erosion of W coatings on graphite/CFC					0.65	
5.	WP10-PWI-05-02-02/MEdC/PS	Tiseanu	X-ray microbeam absorption/fluorescence method as a non-invasive	14,350					

			solution for investigation of the erosion of W coatings on graphite/CFC						
6.	WP10-PWI-02-04-01/MEdC/BS	Dinescu	Removal of codeposited material from gaps with a plasma torch					1.2 ppy	
7.	WP10-PWI-02-04-02/MEdC/BS	Dinescu	Laboratory models for the co-deposited layers					1.0 ppy	
8.	WP10-PWI-02-04-03/MEdC/BS	Dinescu	Production of controlled laboratory co-deposited layers for fuel removal studies					0.4 ppy	
9.	WP10-PWI-04-04-01/MEdC/BS	UAIC	Experimental investigations and numerical studies (ERO) of chemical erosion of low-Z materials for plasmas at low temperatures is one of the experiments in Pilot-PSI / Magnum-PSI.					0.4 ppy	
10.	WP10-PWI-06-01-01/MEdC/BS	Lungu	TVA gun electron beam irradiation influence on mixed films prepared using TVA method					0.6 ppy	
11.	WP10-PWI-06-	Lungu	TVA gun electron beam	5,850					

## PWI 2010 (continued)

	01-02/MEdC/PS		irradiation influence on mixed films prepared using TVA method						
12.	WP10-PWI-06-02-01/MEdC/BS	Lungu	D-retention in mixed materials containing H, D and He					0.6 ppy	
13.	WP10-PWI-06-02-02/MEdC/PS	Lungu	D-retention in mixed materials containing H, D and He	5,850		15,000			

### Total PRIORITY SUPPORT

No	Cod EFDA	Responsabili	Tema	Manpower	Contributie Comisie 8.2a	Hardware	Contributie Comisie 8.2b	Baseline	Obs
1.	WP10-PWI-01	Tiseanu		14,350	2,870	0	0		
2.	WP10-PWI-05	Tiseanu		14,350	2,870		0		
3.	WP10-PWI-06	Lungu, Lungu		11,700	2,340	15,000	6,000		
TOTAL				40,400	8,080		6,000		

**Total of contribution Comission for Priority Support: 8,080+6,000 = 14,080 Euro**



## Integrated Tokamak Modeling 2010 Priority Support

Year	Association	Activity	Manpower		Hardware expenditure	Consumables expenditure	Other expenditures	Total	Comments
			ppy	k€	k€	k€	k€	k€	
2010	MEdC	WP10-ITM-AMNS- ACT3-T1-01/MEdC	0.30	13.20	0.00	0.00	0.00	13.20	
2010	MEdC	WP10-ITM-IMP5- ACT4-T1-01/MEdC	0.50	22.00	0.00	0.00	0.00	22.00	
2010	MEdC	WP10-ITM-ISIP- ACT10-T1-01/MEdC	0.80	14.08	0.00	0.00	0.00	14.08	
2010	MEdC	WP10-ITM-ISIP- ACT3-T1-01/MEdC	0.40	7.04	0.00	0.00	0.00	7.04	

# Association EURATOM - MEdC Annual Expenditure

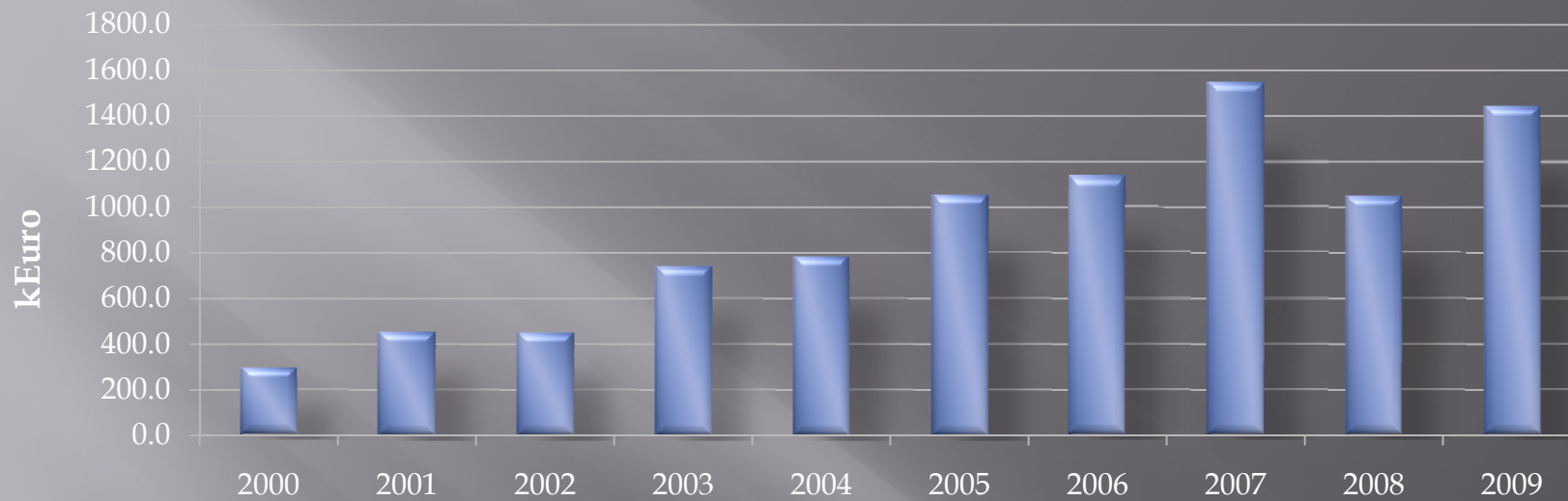

## Expenditure categories (2000-2009)

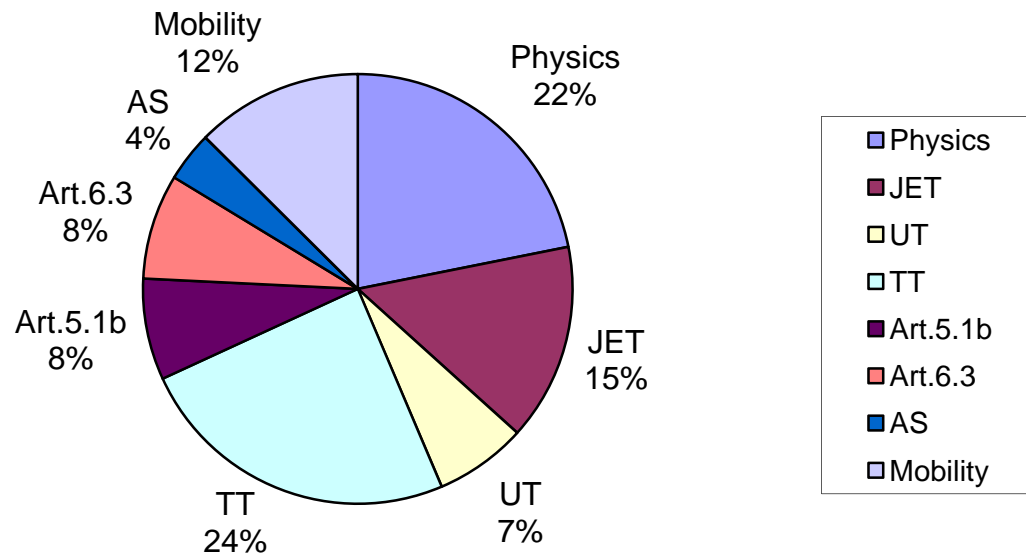

## Baseline expenditure structure (Physics, JET Notifications, UnderliTechnology)

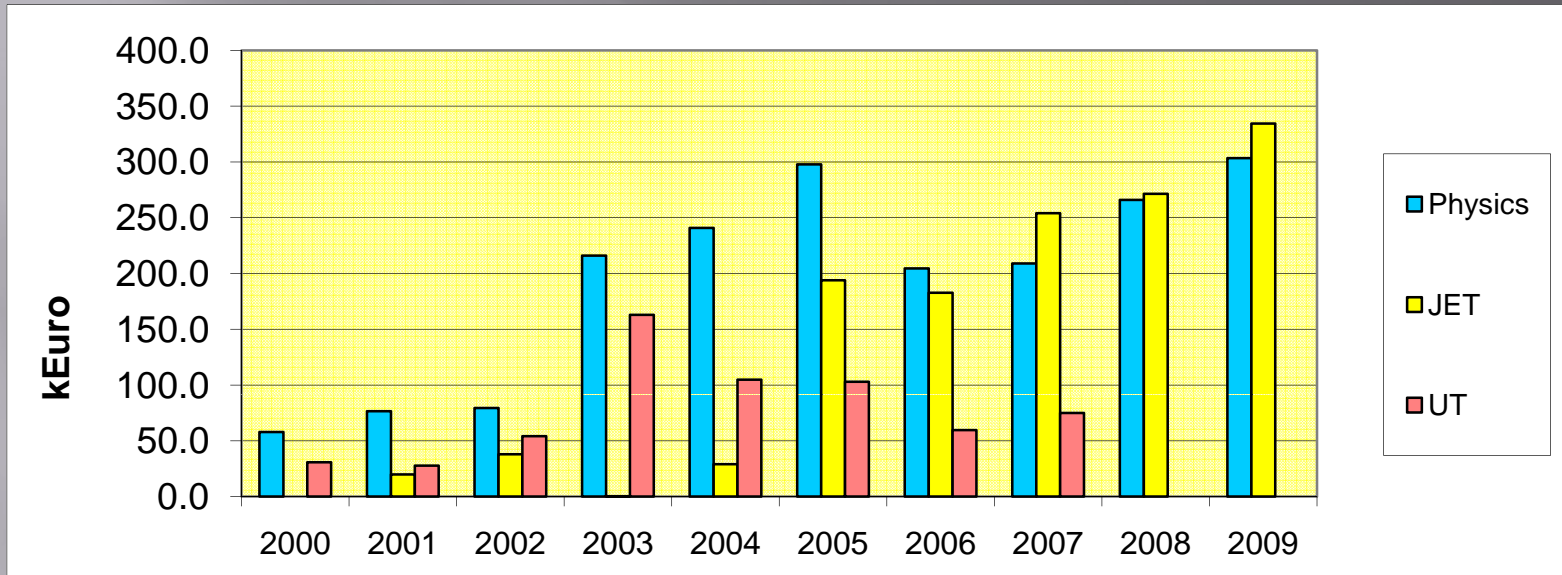

## Expenditure structure evolution (Baseline, Technology Tasks, Art. 5.1b, Art. 6.3)



# Staff evolution

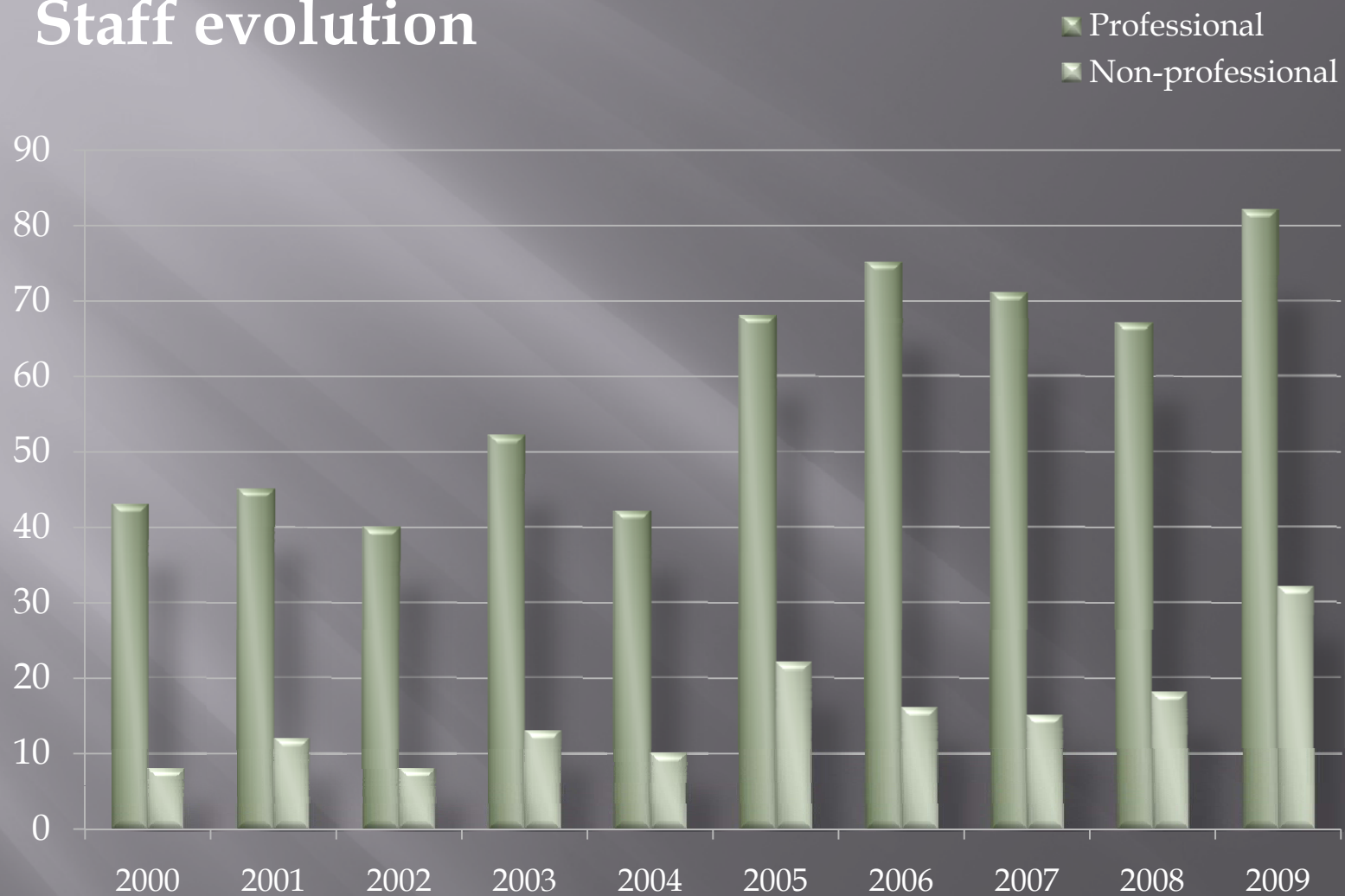

PUBLICATIONS 2002-2008: 194 articles (including 108 in ISI journals)  
219 contributions at conferences

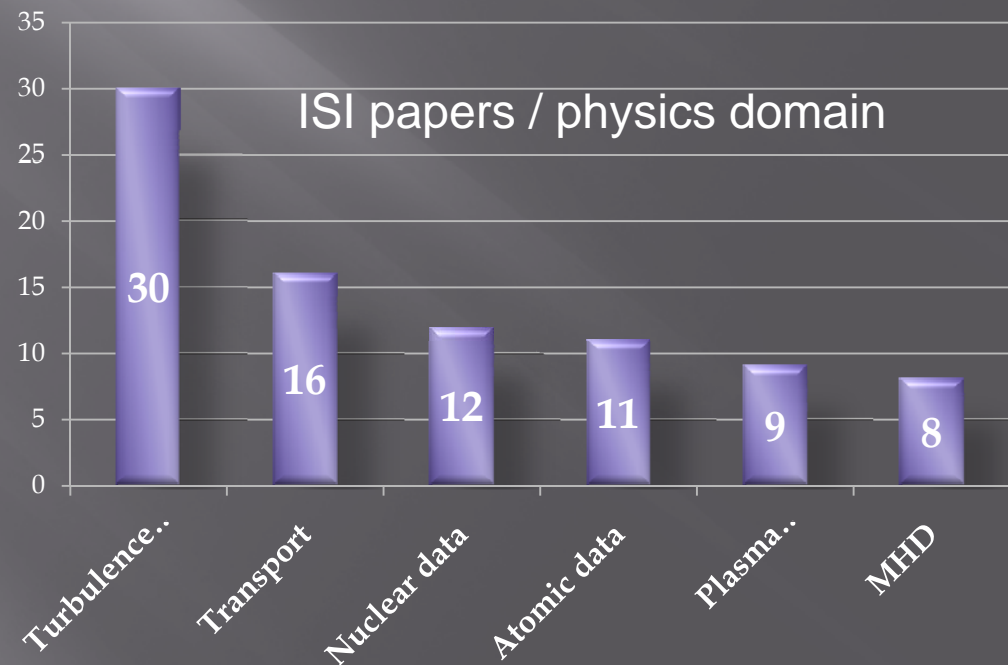
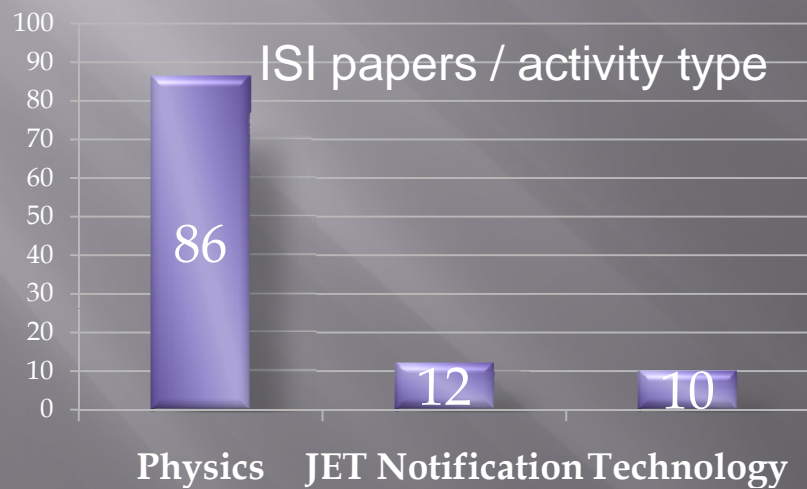
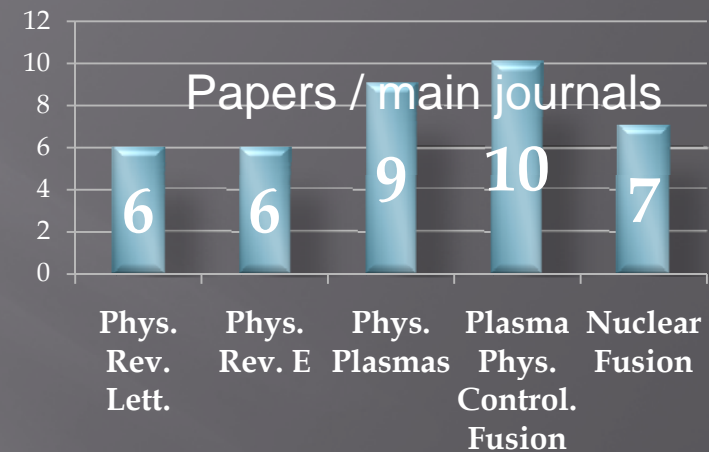
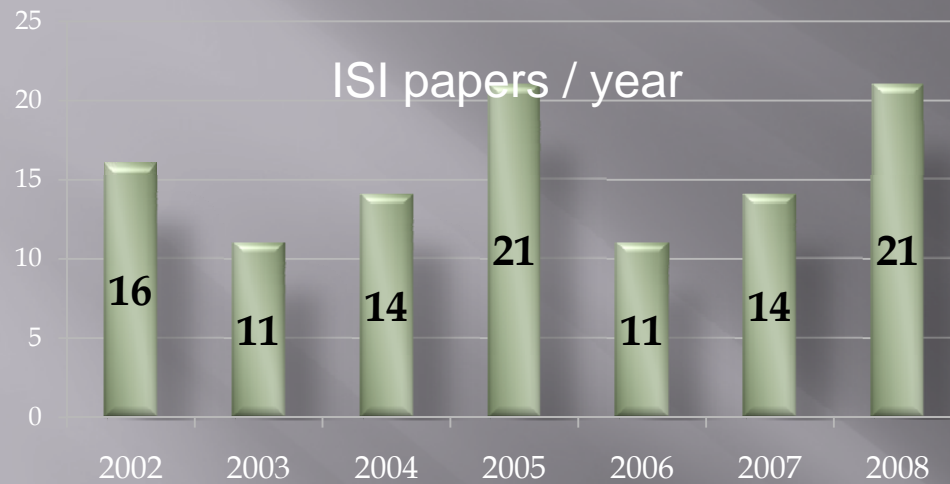

## Expenditure 2005 – 2009 according to Annual Accounts

ANCS

Total expenditure in [EUR]	2005	2006	2007	2008	2009
<b>General Support Expenditure</b>	420,763	470,874	574,098	537,321	636,911
<b>EFDA art.5 la Basic Support Technology (TCN)</b>	460,871	430,258	299,795	90,560	0
<b>EFDA art. 5.1 B contracts</b>	18,468	99,506	304,095	231,024	47,294
<b>EFDA art. 6.3 contracts</b>	1,518	15,280	270,007	70,404	350,111
<b>Specific Co-operative actions 8.2a</b>	0	0	0	0	245,459
<b>Fellowship contracts 8.2e</b>	0	0	0	0	90,152
<b>Total</b>	<b>901,620</b>	<b>1,015,918</b>	<b>1,447,995</b>	<b>929,309</b>	<b>1,369,927</b>
<b>Mobility</b>	<b>122,097</b>	<b>141,589</b>	<b>131,468</b>	<b>115,595</b>	<b>45,000</b>
<b>Total [RON] + Mobility</b>	<b>1,023,717</b>	<b>1,157,507</b>	<b>1,579,463</b>	<b>1,044,904</b>	<b>1,414,927</b>

Commission

Total expenditure in [EUR]	2005	2006	2007	2008	2009
<b>General Support Expenditure</b>	84,153	94,175	114,820	107,464	91,500
<b>EFDA art.5 la Basic Support Technology (TCN)</b>	92,174	86,052	59,959	18,112	0
<b>EFDA art. 5.1 B contracts</b>	7,387	39,802	121,638	92,410	18,918
<b>EFDA art. 6.3 contracts</b>	1,518	15,280	270,007	70,404	350,111
<b>Specific Co-operative actions 8.2a</b>	0	0	0	0	29,166
<b>Fellowship contracts 8.2e</b>	0	0	0	0	90,152
<b>Total</b>	<b>185,232</b>	<b>235,309</b>	<b>566,424</b>	<b>288,390</b>	<b>579,847</b>
<b>Mobility</b>	<b>122,097</b>	<b>141,589</b>	<b>131,468</b>	<b>115,595</b>	<b>45,000</b>
<b>Total [RON] + Mobility</b>	<b>307,329</b>	<b>376,898</b>	<b>697,892</b>	<b>403,985</b>	<b>624,847</b>

% 0.30 0.33 0.44 0.39 0.44

Major research fields  
where MEdC Association has made contributions  
In 2009

Basic physics of fusion plasma  
    Transport, MHD, diagnostics  
Plasma Wall Interaction  
ITER-like Wall Project (JET)

# Physics of fusion plasmas

Physics of instabilities, turbulence and transport in tokamak plasmas

10 researchers, collaborations with CEA, ULB, ENEA, JET

Statistical physics for anomalous transport in plasmas

Mathematical modeling of transport processes

Numerical simulations of transport in stochastic fields

Impurities in ICRH

Results:

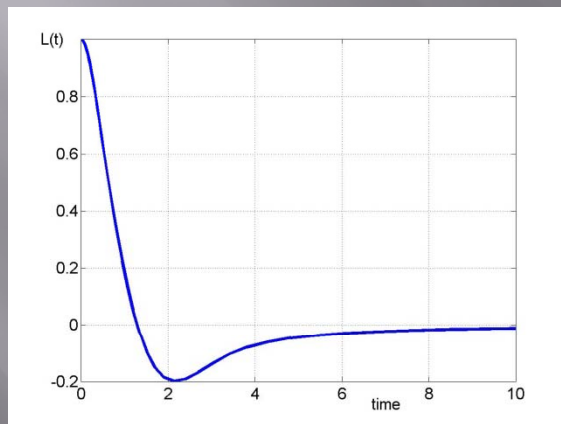

The Correlation of the Lagrangian Velocity in the ExB drift

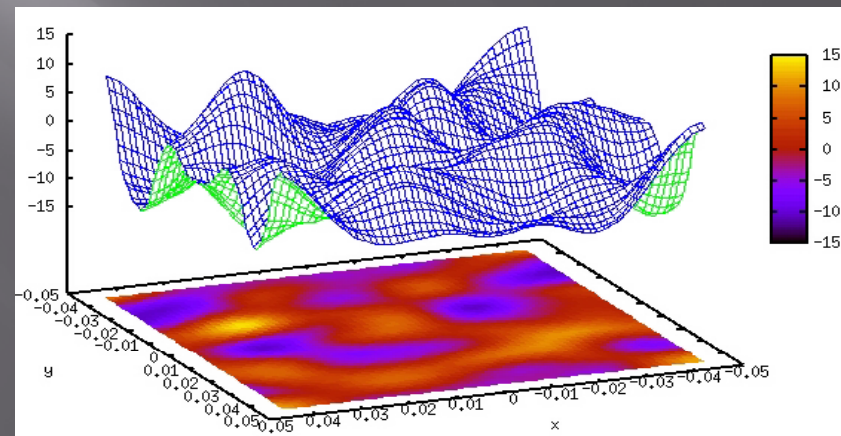

Transport in stochastic Magnetic field



# Physics of fusion plasmas

## Filamentation of the layer of sheared poloidal rotation during an ELM

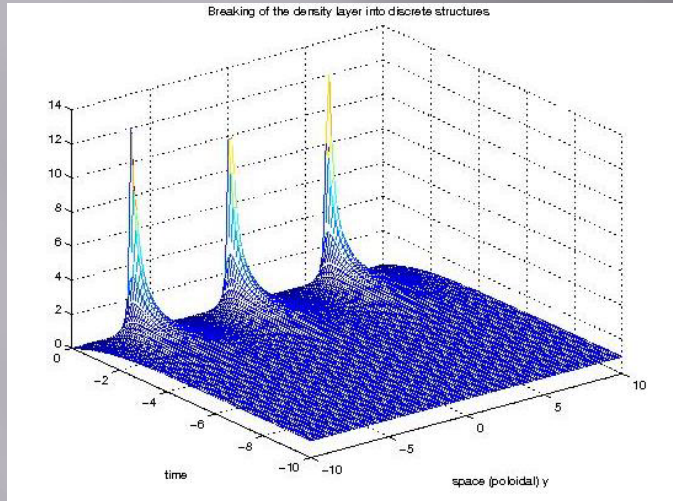

Nonlinear tearing break-up of the layer  
Is due to the instability of the Chaplygin-gas  
with anomalous polytropic

## Magnetic configurations and Resistive Wall Modes. Neoclassical damping

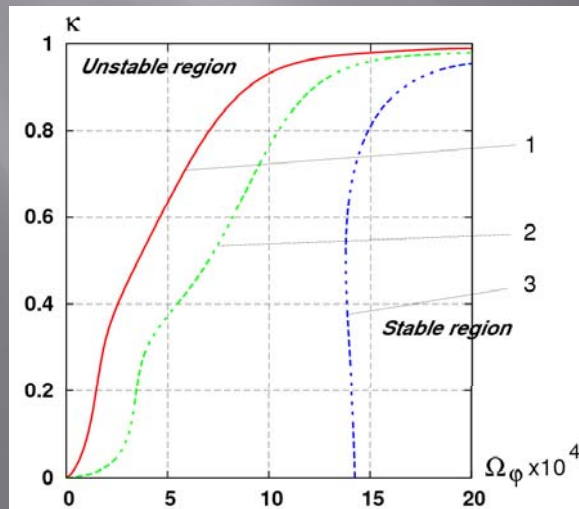

Stability parameter  $\kappa$  as function  
of the toroidal plasma rotation  $\Omega_\phi$ , for  
different plasma flow damping rates  
due to charge exchange with neutrals

# Physics of fusion plasmas

## Experimental measurements on Pilot-PSI

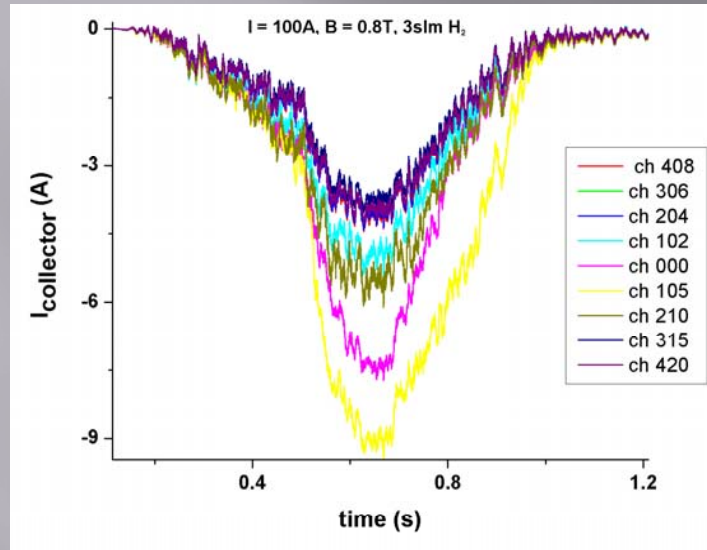

*Current variation on 9 collectors during plasma pulse for  $B = 0.4$  and  $0.8 T$  ( $I_d = 100 A$ )*

## Toroidal angular momentum (analytic and numeric)

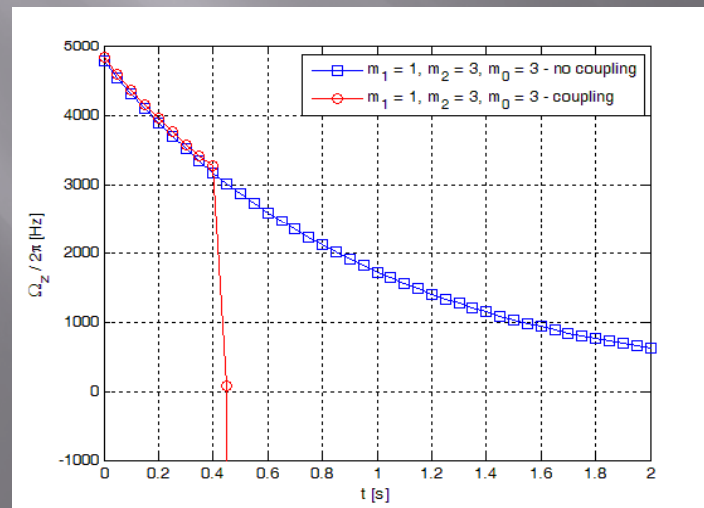

The figure shows the plasma deceleration and rotation braking under error field penetration and Neoclassical viscosity destabilizing influence

# PWI

## Cleaning with a plasma torch and material removal

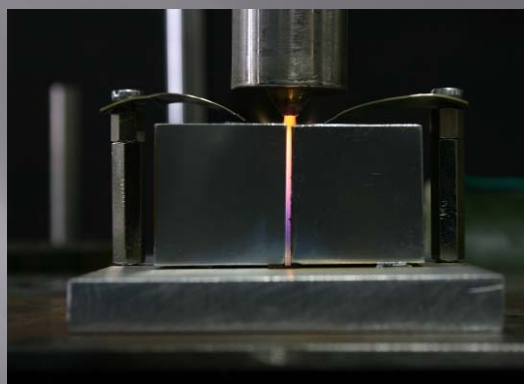
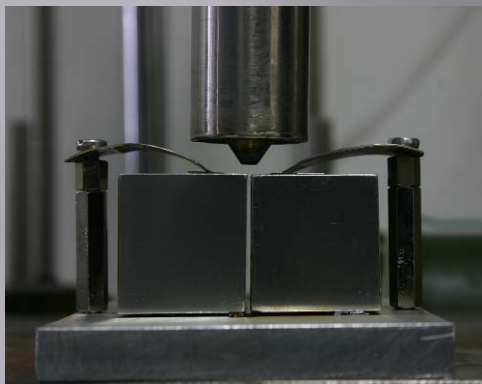

*The positioning of the plasma torch above the gap, b) an image recorded during the cleaning procedure*

## Ternary compounds formation of W, Be and C

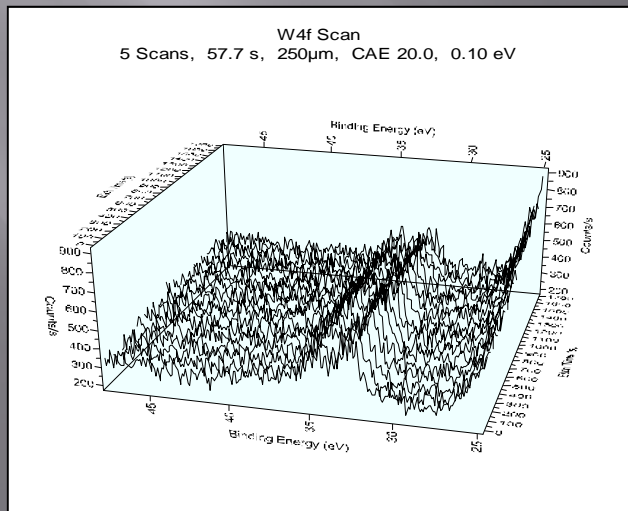

3D representation of the XPS W4f peak shown in Fig.14 reveal the W oxidation at the top of the layer and possible formation of the  $Be_xW_y$  chemical compound

# Topical Groups Tasks

*Providing coated samples for Laser Induced Breakdown System (LIBS)*

Depth profiles of W, Mo, C, O and Ti concentration for the samples to be used in LIBS application

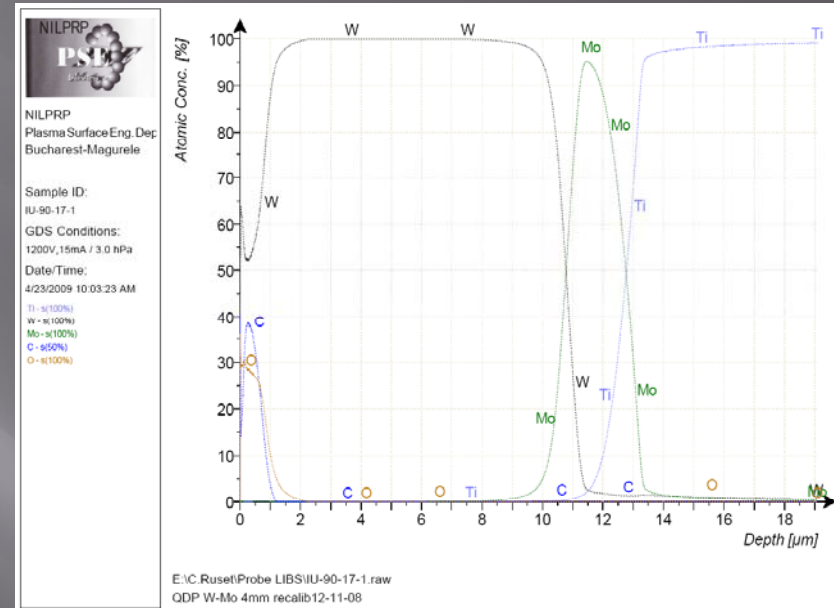

*Tungsten erosion in the JET divertor*

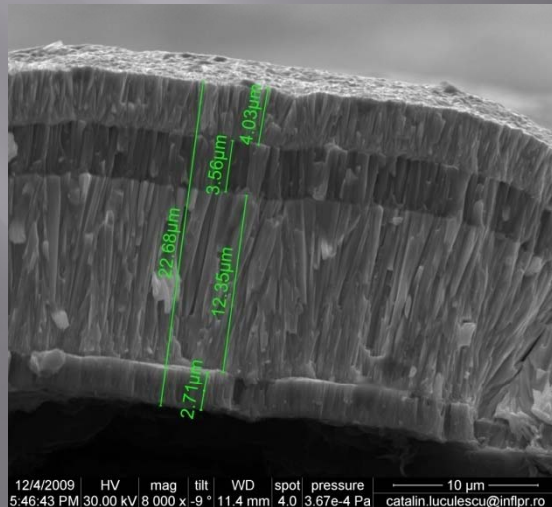

SEM micrograph of the W/Mo markers

# QUALIFICATION OF THE X-RAY MICRO-BEAM ABSORPTION/FLUORESCENCE METHOD FOR EROSION ANALYSIS

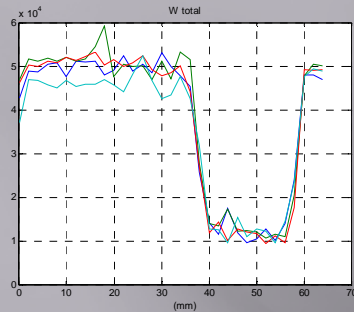

Line profiles along the map

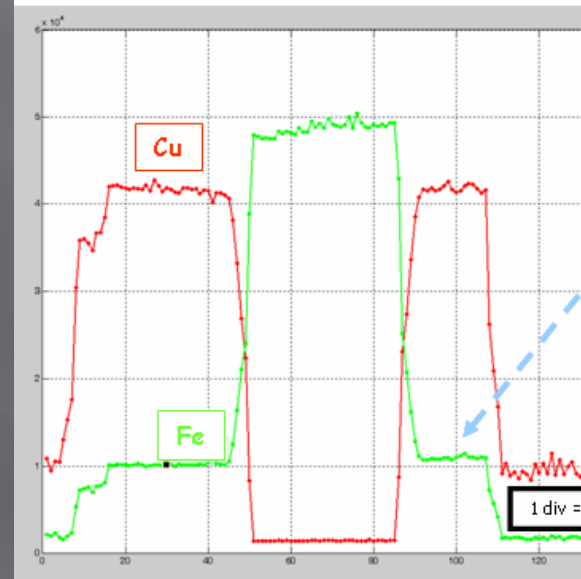
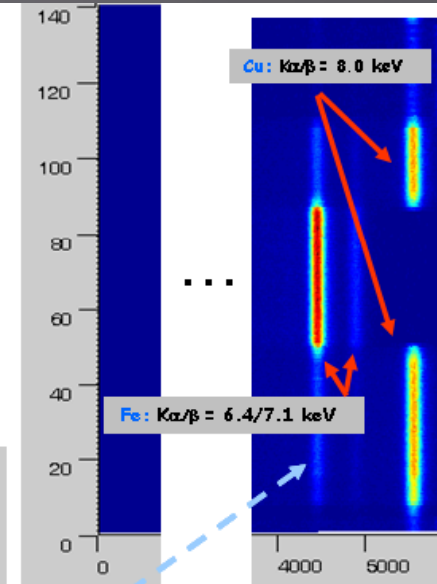
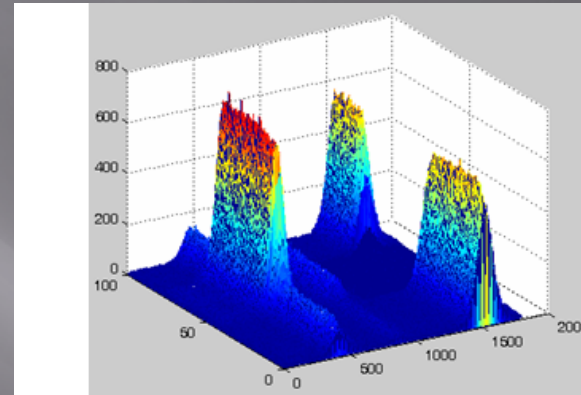

Fe X-ray lines penetrates the Cu layer and permit the determination of the Cu layer thickness

Post-mortem analysis of W coated fine graphite tiles from the divertor of ASDEX-Upgrade by X-ray Microbeam fluorescence

# Participation to the JET Experimental Program

Experimental Campaigns C20 – C27

SHFD neutrons

Plasma Tomography

*Profile reconstruction techniques  
for the jet neutron  
and gamma-ray cameras*

Phantom	Reconstruction method			
	ML	ME	TR	MCBP
peak	0.993	0.990	0.989	0.996
hollow	0.961	0.949	0.951	0.870
“banana”	0.935	0.931	0.908	0.857
symmetrically reversed “banana”	0.875	0.861	0.836	0.832
peak plus “banana”	0.874	0.667	0.837	0.844

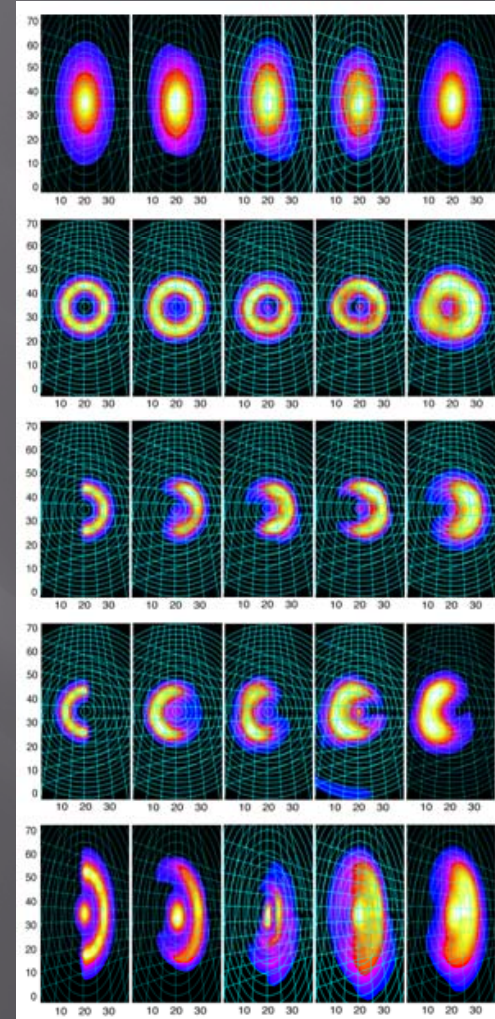

# Enhancement of gamma-ray diagnostics at JET

KN3 - NA

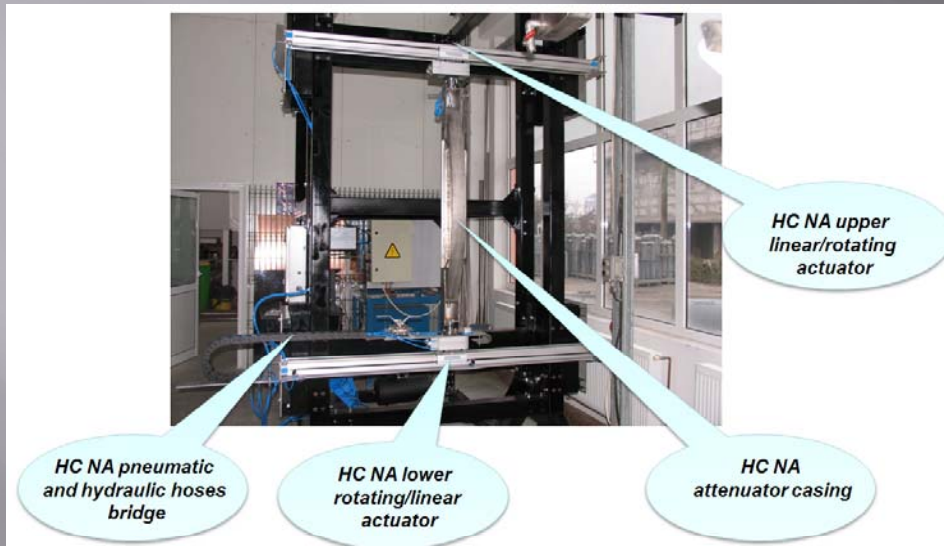

*KN3-NA horizontal camera installed*

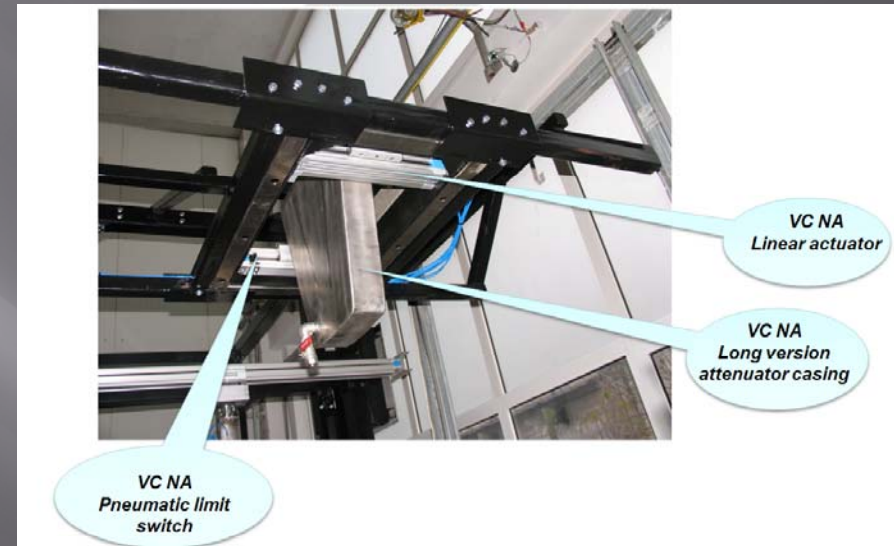

*KN3-NA Vertical Camera assembled*

# Tandem Collimators for the Tangential GammaRay Spectrometer - KM6T-TC

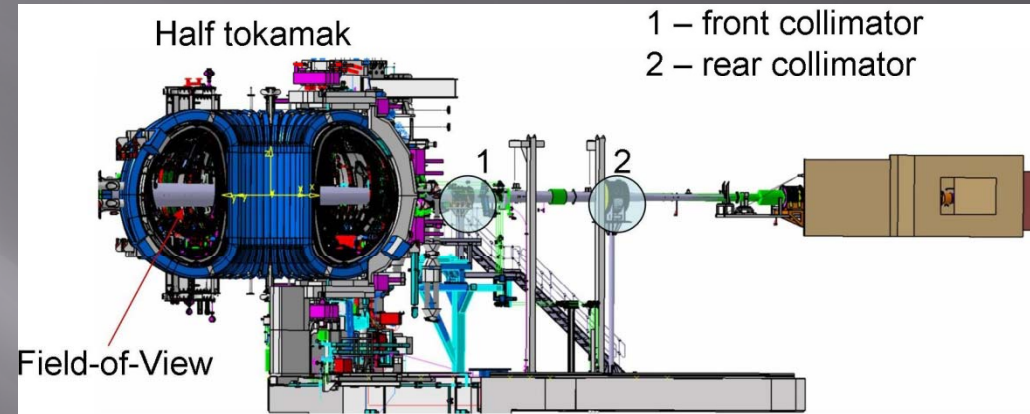
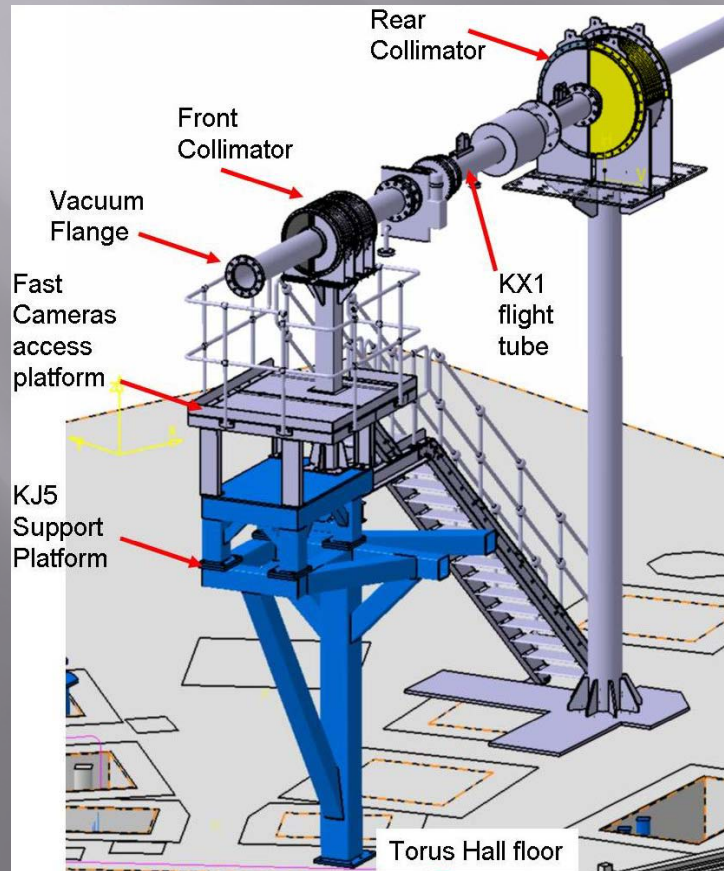



# Optimization and Manufacturing of 10 $\mu\text{m}$ W-coatings for the CFC tiles to be installed in JET

ITER-like Wall at JET



*CMSII coating equipment general view*



*W coated tiles during the HHF test*

Extension to JET divertor 2009

# PRODUCTION OF BERYLLIUM COATINGS FOR INCONEL CLADDING AND BERYLLIUM TILE MARKERS FOR THE ITER-LIKE WALL PROJECT

Thermionic vacuum arc (TVA) method

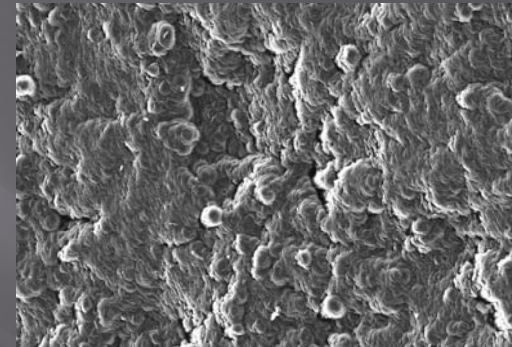
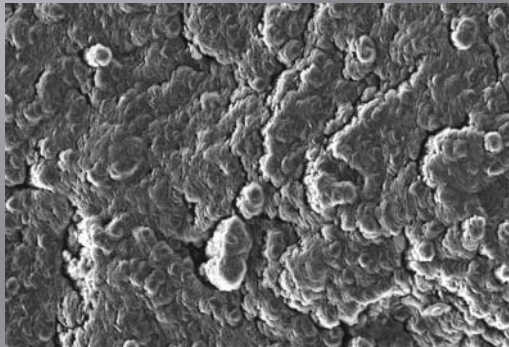

*Beryllium coatings on inconel: (a) “as produced”; (b) after HHF test of 20 MJ m<sup>-2</sup>.*

Interest expressed by Fusion for Energy, for ITER applications (2009)

# Conclusions

## Major achievements:

physics: Transport, MHD, ITM  
W- and Be – coating on JET Wall  
Plasma Wall Interaction  
diagnostics upgrade

## Missed opportunities

High Performance Computer for Fusion Physics

## Perspectives

F4E

## Still to solve:

Do-we have a strategy for ITER?  
Are-we at the periphery or on the main stream?  
How to conserve the physics expertise

Few words about ITER and F4E in relation with the Association  
The success of ITER is the exclusive condition of our past and present work

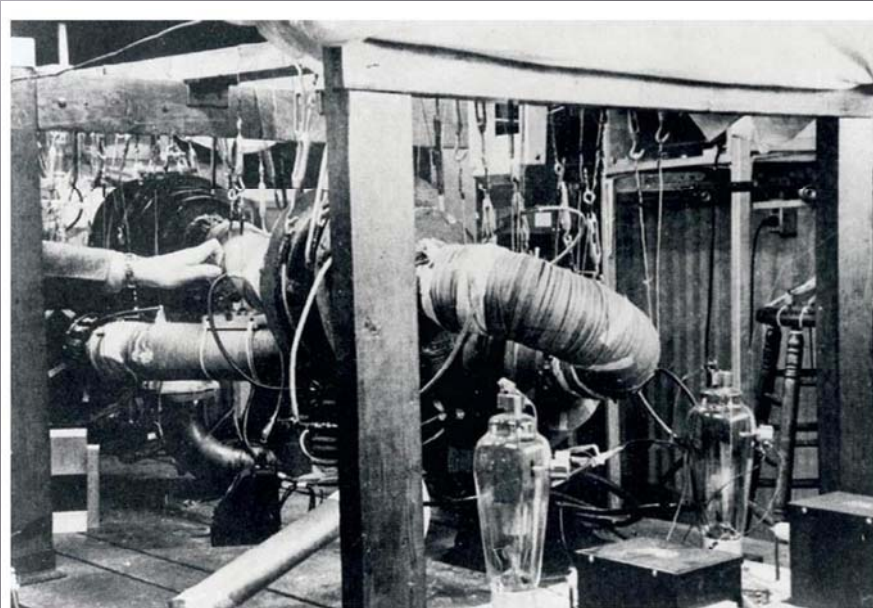

PPPL

*The Stellarator A, built at the Princeton Plasma Physics Laboratory in 1952, was Lyman Spitzer's first fusion machine. Its small size can be gauged by the hand at left. The early stellarators bent the torus into a figure eight. Later stellarators were larger, and had more instabilities than the early tandem mirrors.*

## ITER timeline

1985



The European Union (EU), Japan, the then Soviet Union and US enter into a collaboration to build an experimental reactor that aims to demonstrate the scientific and technical practicality of fusion power.

1988

Conceptual design activity for ITER starts, with the aim of demonstrating the feasibility of controlled ignition in deuterium–tritium plasmas with steady-state burning. The design takes two years to complete.

1992

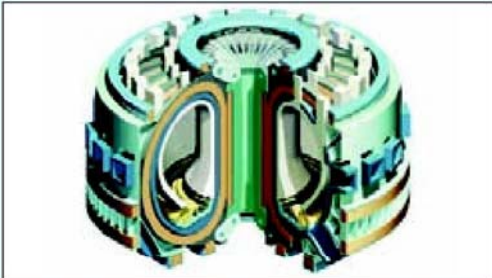

Engineering design activities for ITER begin, looking at the complete technical design specifications necessary to construct a 1.5 GW fusion reactor.

1998

The final engineering design report is approved by the ITER council, which supervises the organization and budget of the project. However, ITER members demand that costs are cut by 50%, so the engineering design is revised.

1999

The US withdraws from the project over doubts that the design would work as planned, citing excessive construction costs.

2001

Canada gains ITER membership, while the design revision is completed for a 500 MW reactor at an estimated cost of €4.6bn.

2002

The EU proposes Cadarache, about 60 km from Marseille in France, and Vandellòs, around 100 km from Barcelona in Spain, as candidate sites for ITER, while Japan proposes Rokkasho, on the northern tip of Honshu Island in central Japan, and Canada proposes Clarington on the north shore of Lake Ontario, some 60 km east of Toronto.

2003



The US rejoins ITER and it is followed by new members China and South Korea, while Canada withdraws its support due to a lack of federal funding. Cadarache in France is chosen as the favoured European site to hold ITER.

2005



Ministers from ITER's six members pick Cadarache to host ITER, while Japan gets given the International Fusion Materials Irradiation Facility designed to test suitable materials for use in a fusion reactor. Japan's Kaname Iweda becomes the first director general of the project. Later in the year India becomes the seventh member of ITER.

2007

The US cancels funding for ITER in the 2008 financial year.

2008

The project is delayed by two years until 2018 and a proposed update to the 2001 design could increase the cost further. The US reinstates \$16m to the project in its "supplemental" spending bill for 2008.

(2010 Motojima)



2009: Problem of financing due to major increase of cost.  
The need is of 1.4 billion euro for 2012 and 2013.

How much research is left?

## List of activities of Romanian Research Institutions in response to F4E Calls

*“Improvement of nuclear data, development of tools and experimentals/validation in support of ITER activities”*,  
Grant F4E-2008-GRT-014 (ES-AC),  
financial value of 57500 EUR for Task 6,  
attributed to National Institute of Physics and Nuclear Engineering (IFIN-HH)  
(end date 21 May 2010)

**The following contracts are in various stages:**

### Contract 1

Contract F4E-2010-GRT-045 (PNS-VTP) – *“Finalization of the system capacity, enhancements studies and detailed design of WDS components including HAZOP studies”*, contract obtained by the consortium **“Tritium Plant Consortium of Associates (TriPla-CA)”** (KIT, ICIT, ENEA, CEA), will be signed end-June or first part of July 2010.

ICIT (Institute of Cryogeny and Isotope Technology) has a mandate from the MEdC Association to be involved and to manage the participation to this Consortium.

## Contract 2

Within the Contract F4E-BA (Broader Approach):

*“Technical specification for quality control monitoring of NBTI strands and conductor for JT60-SA TF coils: Extended Geometry”*

The Romanian contractor is the

National Institute for Laser, Plasma and Radiation Physics (NILPRP),  
the Laboratory of X-Ray Microtomography.

The Contract will signed end-August but the official start date will be in October 2010, after the signature of the procurement contract for the TF superconducting cables at JT60-SA.

## Contract 3

*“Nuclear Data Files”*, proposal for creation of a Consortium following the Call for Grant F4E nr. F4E-2008-GRT-056 (ES-AC),

financial value 80,000 euro for Task 5 to be attributed to the National Institute of Physics and Nuclear Engineering (IFIN-HH)